

# SERIES 6C

6115 C // 6125 C // 6135 C  
POWERSHIFT - RVSHIFT - TTV  
STAGE IV EPA



**DEUTZ  
FAHR**

# // THE NEW SERIES 6C

## CONFIGURABILITY

Extreme configurability in a tractor means that it can cater effectively for the needs of any application. This was the principle guiding DEUTZ-FAHR in the development of the new Series 6C, a family of 3 models with power outputs from 116 to 136 HP, 3 different transmission variants and a wide choice of options letting the customer tailor the ideal machine for their specific requirements. Like for example the tyre combinations offered which ensure a high ground clearance of up to 505 mm which is ideal for plant protection and fertilisation in late growth stages.

## TOPVISION CAB FAMILY

A highly comfortable working environment makes your job simpler, more enjoyable and less tiring. This is why the new Series 6C models have been equipped with the new 4-pillar TopVision, TopVision+ and TopVision<sup>Pro</sup> cabs (depending on model/transmission). Thanks to the 4-pillar structure and the high visibility roof these cabs boast unrivalled all-round visibility. In addition you will benefit from the quietness as well as minimal vibration and best comfort thanks to the optional cab suspension. Additional convenience features like the DAB+ radio with 4 premium loud speakers as well as the optional integrated fridge will even let you enjoy long working days.

## HYDRAULIC SYSTEM

With a Load Sensing hydraulic system capable of delivering up to 120 l/min of oil, even implements with very high flow rate demands are no challenge for the Series 6C. In addition to this, with up to 5 rear spool valves of which one can be switched to be used in the front, a dedicated valve for the front lift and Power Beyond connections offer unparalleled flexibility for working with any hydraulic implement. The high hydraulic flow in combination with the electronic joystick makes the Series 6C ideal for front loader operation.



## POWERSHIFT TRANSMISSION

An essential and precise transmission. The base transmission consists of a 5 speed gearbox with a 3 stage Powershift unit which includes an Automatic Powershift function (APS). All models offering 2 or optionally 4 ranges, including a creeper range.

# As versatile as a farm can be.

**EXTRAORDINARY AGILITY, EXTREME EFFICIENCY AND UNPRECEDENTED OPERATOR COMFORT: THIS IS THE NEW SERIES 6C.**



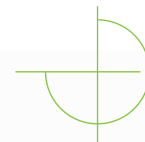

## RVSHIFT TRANSMISSION

High technology manageable through a single and simple joystick. The RVshift transmission offers a choice of 20 forward and 16 reverse speeds selectable as easily as with a Full Powershift transmission. Optionally the RVshift transmission can be equipped with a creeper.



## TTV TRANSMISSION

An infinite choice of ratios for unrivalled precision and efficiency. The TTV transmission combines state of the art technology with extraordinary efficiency to meet the needs of any task imaginable.

The new Series 6C was specifically conceived to deliver outstanding performance in any situation, from the most heavy duty soil preparation tasks, sowing, fertilising and applying protective crop treatments to harvesting or transport. With its adjustable PowerShuttle, compact dimensions, outstanding agility and high hydraulic flow, the Series 6C also shines in any application with a front loader. An ultra-modern functional design, a comprehensive choice of transmissions, a host of integrated SDF Smart Farming Solutions as options (such as 8" iMonitor, ISOBUS and autoguidance) complement each other to perfection in the models of the Series 6C, to offer the ideal answer to the functional needs of every possible application, together with excellent operator comfort and low running costs.

As well as all this, other features and functionalities such as extremely efficient 4-cylinder engines with minimised maintenance, highly configurable hydraulic systems, 50 kph versions, front axle suspension with all-wheel braking, rear lifts with maximum capacities from 5000 to 7000 Kg, high maximum gross vehicle weights and new TopVision cabs also count among the many class-beating strengths of the new DEUTZ-FAHR Series 6C.

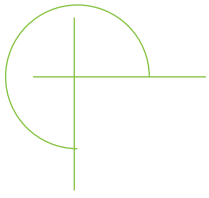

# // PRODUCE

A tractor must always be capable of working at full capacity to get the job done quickly.

DEUTZ-FAHR's answer to this need is the new Series 6C.



# TIVITY





# // ENGINE

It's all about power.

The powerful 4 cylinder FARMotion engines are the perfect example of state of the art technology, and are synonymous with extreme reliability and efficiency. These attributes allow the tractors of the new Series 6C to deliver outstanding results in terms of both performance and economy. As well as meeting the most stringent environmental standards, these powerplants boast extraordinarily responsive power

delivery and produce generous torque across a wide range of engine speeds. To comply with the requirements of Stage IV EPA emissions regulations, the engines use an SCR system. This solution ensures not only a low fuel consumption but also lowest AdBlue consumption and as a result extremely low running cost. These new engines have maximum power outputs up to 116/126/136 HP (in the 6115 C, 6125 C and 6135



> FARMotion engine.

> Electronic hand throttle with 2 engine memory speeds.



## HIGHLIGHTS

- > 4-cyl. FARMotion engines
- > Electronic controlled viscstatic fan (e-Visco)
- > Hydraulic Engine Brake (HEB)

C models respectively) in normal operating conditions. A viscstatic fan reduces power losses and also contributes to reducing fuel consumption. As an option, the tractor can also be equipped with an electronically controlled e-Visco fan, with automatic adjustment of the speed in relation to the actual cooling demand, independently of engine speed. This fan is always installed on tractors

equipped with the optional Hydraulic Engine Brake (HEB), a solution which engages both the hydraulic system pump and the fan to increase the engine brake effect by 40% and reduce service brake overheating and wear.



# // POWERSHIFT TRANSMISSION

It's all about efficiency.

The new DEUTZ-FAHR Series 6C with Powershift transmission is equipped with transmissions offering up to 5 manually selected speeds, 4 work ranges, 3 Powershift steps and a PowerShuttle. All versions with the 3-stage Powershift also come with the Speed-Matching function and an Automatic Powershift (APS), which is fully adjustable to suit the preferences of the operator. This means that up to 60+60 speeds are available, letting the operator choose the perfect ratio for any task.

The PowerShuttle has 5 user-selectable responsiveness levels and lets the operator change direction without using the clutch, for complete safety even when working on a gradient and under load. The ability to switch rapidly between forward and reverse drive without interrupting torque delivery to the wheels not only makes work simpler but also significantly improves productivity in tasks such as working with a front loader.

The transmission also features the renewed Stop&Go system, which facilitates very precise manoeuvring in narrowly spaces, allowing the driver to stop the tractor and set off again without using the clutch. The Powershift version of the transmission includes also the ComfortClutch function, which lets the operator shift gear by simply pressing a button on the gear knob instead of using the clutch pedal. The new models of the Powershift Series 6C are capable of a top speed of 40 kph at an engine speed below 1800 rpm.

## HIGHLIGHTS

- > PowerShuttle with 5 adjustable settings
- > Speed-Matching and APS function
- > Stop&Go and ComfortClutch as standard
- > Min. speed 0.1 Kph - Max. speed 40 Kph ECO



> 6125 C and 6135 C Powershift console.





> APS activation with adjustable response.



# // RVSHIFT TRANSMISSION

It's all about simplicity.

The new, high efficiency RVshift transmission is based on a Full Powershift concept. It features 20 forward and 16 reverse speeds, all of which selectable without using the clutch pedal and without interrupting torque delivery.

Developed specifically for the new Series 6C by DEUTZ-FAHR it stands for absolute simplicity, high efficiency and guarantees to make the tractor easy to use by anyone. The control element of the new RVshift transmission is the new RVshift controller, a 3-way joystick, located on the multifunction armrest mounted onto the driver seat. Pushing it forward, the transmission performs an up-shift while a downshift is carried out when it is pulled backwards. For added convenience the current speed can easily be stored and enabled, with a simple

push of the RVshift controller to the left. For a quick switch between fast transport application and field work the RVshift transmission features two driving modes (Field and Transport). With a simple push of a button, which is located close to the RVshift controller, it is possible to switch from one mode to the other without having to shift through all the gears. The modes are pre-programmed from factory but also easily adjustable according to the individual needs.

The driver is hugely assisted during transport or field work thanks to the Automatic Powershift function (APS). After activation via the APS button the system shifts according to the load all the gears programmed in the field or road driving mode.





# HIGHLIGHTS

- > Basic or Advanced Armrest
- > PowerShuttle with 5 adjustable settings
- > Automatic Powershift (APS) and Cruise Control
- > Advanced Stop&Go and Hydraulic ParkBrake (HPB)
- > Creeper with infinitely variable speeds from 20 m/h to 5 kph
- > Max. speed 50kph ECO

An additional highlight of the RVshift transmission is the new advanced Stop&Go system with features in addition also a Stop&Hold function, which keeps the tractor stopped until the accelerator gets pressed again. For total safety when stopping and parking the machine, especially on gradients, the RVshift transmission includes the Hydraulic Parking Brake (HPB) as standard which, among other advantages, also minimises energy wastage while the machine is in motion.

Optional RVshift features:

Creeper: For all with the need of very low working speeds the RVshift transmission offers a Creeper mode

with infinitely variable speeds from 20 m/h to 5 kph. In that way, for example, a vegetable planter, a potato harvester, a stone crusher or a snow blower can be operated at it's performance limits, ensuring a maximum output. Advanced satellite armrest: For all demanding highest flexibility the Series 6C can be delivered with the advanced satellite armrest. With it, the RVshift controller contains 3 freely programmable jolly buttons and a freely programmable jolly thumbwheel. The buttons as well as the thumbwheel are programmable in accordance with the needs of the driver. In addition the advanced version contains also an additional engine speed memory.

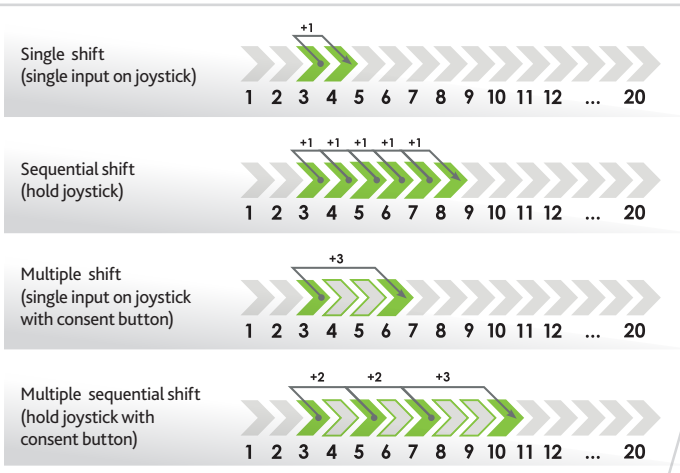

> Shift modes.



> Basic armrest.



> Transport, Field, Creeper driving modes selection.



> Advanced armrest.

# // TTV TRANSMISSION

It's all about technology.

The TTV transmission set benchmarks in this class for efficiency and reliability and represents the state of the art in transmission technology for agricultural tractors. It offers a range of speeds from 0.02 to 50 kph – which is unique in this power class. Every single detail is designed to maximise productivity, while the sophisticated new control and software also improve drivability. The TTV transmission delivers uniform and seamlessly smooth power in all conditions without jolting and stands for high efficiency, low fuel consumption and extreme tractive power. It combines unbeatable mechanical strength with weight-saving solutions used for moving parts in particular, which minimise inertia and allow the unit to attain extremely high levels of efficiency. It has also been introduced with an automatic range shift. All of this translates to a substantial increase in the torque effectively transmissible to the wheels, and a distinct improvement in draft capacity.

The TTV transmission feature 3 driving modes (Automatic, PTO and Manual), to offer the ideal solution for any task. A dial lets the operator select mixed settings between ECO mode, which minimises fuel consumption, and Power mode, which maximises tractor performance.

An advantage of the TTV transmissions is the ability to travel at high road transport speeds while the engine running at low speeds: a speed of 50 kph is achieved with the engine running at less than 1,900 rpm, while 40 kph are attainable at engine speeds below 1,600 rpm. All versions come as standard with the Hydraulic Parking Brake (HPB) and the PowerZero function which maximises safety and comfort even when working on the steepest gradients by holding the vehicle securely in a stationary position without requiring the operator to use the brake or clutch pedals. The TTV transmission is also equipped with the proven PowerShuttle, with 5 predefined responsiveness levels selectable by the user for the best results in any situation.

## HIGHLIGHTS

- > Armrest with MaxCom joystick
- > PowerShuttle with 5 adjustable settings
- > 2 Cruise Control memories and PowerZero function
- > Hydraulic Park-Brake (HPB)
- > Max. speed 50kph ECO







> MaxCom joystick.



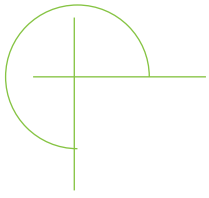

# // CONFIG



Offering endless scope for configuration, with 3 models, power outputs from 116 to 136 HP, a choice of 3 transmission types, strong hydraulic systems with Load Sensing pumps with capacities up to 120 l/min and a host of options, these tractors can be tailored to perfection for even the most specific need.

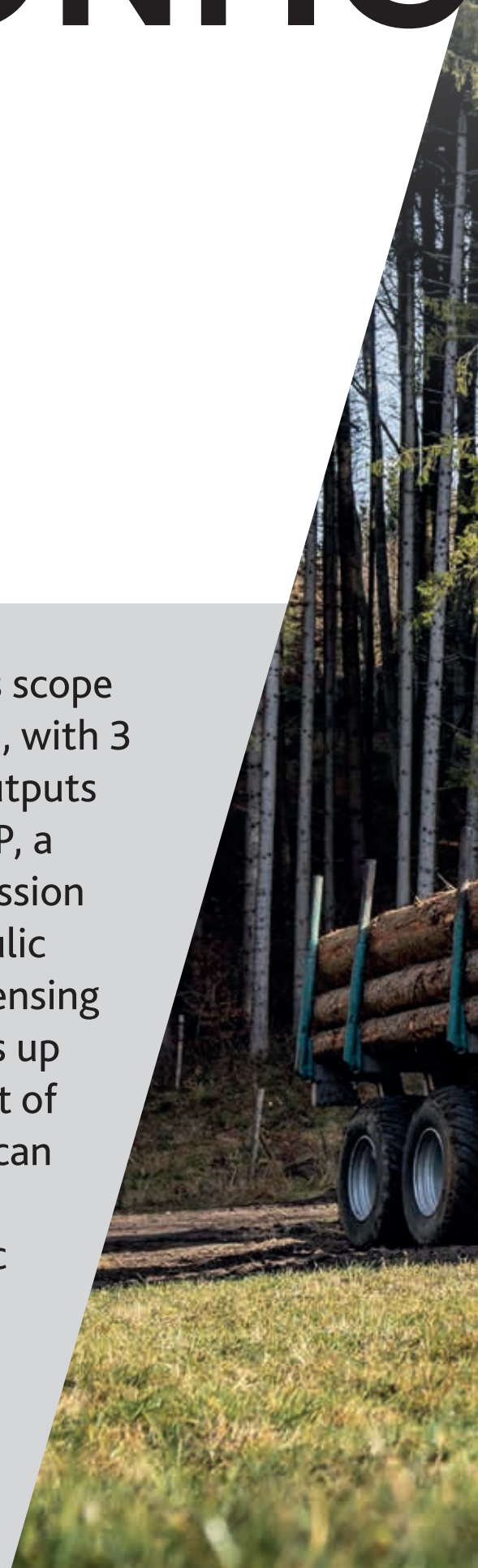



# URABILITY





# // HYDRAULICS

It's all about modularity.

In accordance with a modular concept, the Series 6C can be fitted with a hydraulic system with a 90 l/min gear pump which, depending on the models, can be replaced with an optional Load Sensing system with a 120 l/min pump. These tractors also offer extensive scope for configuring the distributors, and may be equipped with up to 5 rear hydraulic valves, one front duplicated valve and the Power Beyond high flow rate system. On models with the 120 l/min Load Sensing

pump, two of the rear distributors may be electronically controlled, allowing for timer-controlled operation either from the dedicated in-cab controls or from the iMonitor. In addition, the oil flow can be individually adjusted on all high-flow valves. All versions are equipped with a supplementary independent pump with an output of approximately 40 l/min dedicated to the hydraulic steering and auxiliary utilities, to ensure smooth, precise steering action even at low engine

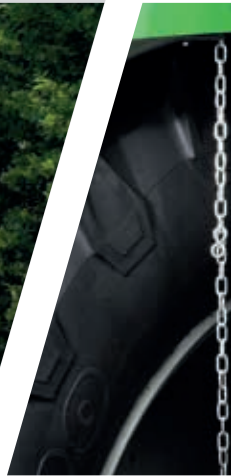



# HIGHLIGHTS

- > 120 l/min Load Sensing pump
- > Mixed hydraulic configuration (mechanical + electronic controls)
- > Up to 5 rear hydraulic valves
- > Independent steering pump

speeds and when using the lifts or while working with the front loader. Exclusively on versions with RVshift and TTV transmissions, ordered with the Performance Steering pre-disposition, an additional 29 l/min pump is included to increase and optimise steering performance when manoeuvring or when using the Performance Steering autoguidance system.

The generous capacity of the hydraulic system and the well placed electronic joystick allowing smooth, dynamic use of a front loader, making the models of the 6C family multi-role workhorses that are also ideal for general farm tasks.

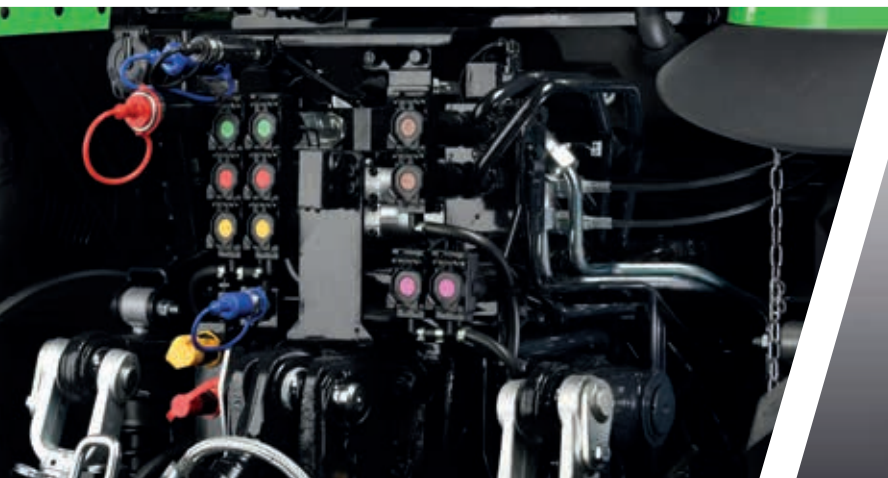

> Up to 10 rear outlets.



> Front outlets.



> Mechanical and electronic hydraulic controls.



> Power Beyond.

# // PTO AND LIFT

It's all about working effectively.

Total configurability for coupling the machine to every possible type of implement is a crucial prerequisite for the versatility of the tractor and ensuring the highest possible efficiency in any task. As on higher power tractors, the new Series 6C comes as standard with a progressively controlled electrohydraulic PTO clutch with automatic implement load measuring to ensure the smoothest starts even with implements with high mass rotating parts. Also as standard, all models in the family are equipped with a removable splined output stub shaft, allowing the PTO to be adapted quickly and safely to work effectively with any type of drive shaft. On tractor versions with Powershift transmissions, the PTO comes as standard with 4 PTO speeds (540/540ECO/1000/1000ECO). RVshift and TTV versions are equipped as standard with a rear PTO with 3 operating modes: 540 rpm, 540ECO and 1000 rpm. All models of the Series 6C may be equipped as optional with a 1000 rpm front PTO, which comes together with a potent front lift with a load capacity of 3000 Kg.

The maximum load capacity of the rear lift is from 5000 to 7000 Kg, depending on model and the options installed. The 3-point linkage is available with category II or IIIN, while the rear lift is fully electronically controlled for extreme precision and speed. An Auto PTO function maximises productivity when working in the field, while an integrated active damping system of the rear lift mitigates oscillation when carrying mounted implements with significant overhangs.



> Electronic rear lift controls.





# HIGHLIGHTS

- > Auto PTO function
- > Electronic rear lift
- > Up to 7000 Kg lifting capacity



> External controls for PTO and rear lift.



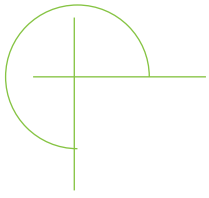

# // COMFO



A modern tractor must ensure outstanding operator comfort and offer an extensive choice of variants and configurations to cater for every possible need. The new DEUTZ-FAHR Series 6C achieves all of this and more!



RT





# // TOPVISION

It's all about visibility.

The new TopVision cab family is based on three different versions. Boasting an advanced 4-pillar design and very generous glazing, the new cabs offer extraordinary all-round visibility. In combination with the additional high visibility roof the work with the front loader becomes a real pleasure. And with the generous work light pack with up to 12 LED worklights, visibility is excellent even in total darkness. All versions offering a very low noise and vibration level, superior quality trim materials and ergonomically organised controls. A fully adjustable steering column and suspended premium seats let all operators find the perfect driving position. And if an openable front window is preferred, this option is available on all models as well. The air conditioning system is equipped with a lot of vents around the driver which are perfectly distributing the fresh air around all of the cab. This keeps the cab not only comfortably cool during summer time but also warm and cosy during winter season. And to help make your job easier and safer even in the coldest weather, the TopVision<sup>+</sup> and TopVision<sup>pro</sup> can be equipped also with electrical adjustment and heated rear mirrors as well as rear window with defrost function. The many other options on offer include a factory-fitted bracket for mounting a monitor or other supplementary device for controlling implements, a passenger seat, a DAB+ radio system, power sockets (including USB ports) and a practical smartphone and cup holders. All cabs feature for a high level of comfort an innovative Hydro Silent-Block suspension as standard, which reduces vibrations transmitted to the operator up to 40%. For premium level comfort, the TopVision<sup>+</sup> and TopVision<sup>pro</sup> versions are also available with the highly effective mechanical cab suspension. Additionally they can be also ordered with a removable cooling box. The models with Powershift transmission are equipped with the new TopVision or TopVision<sup>+</sup> cabs. The layout of the side console has been developed in line with the latest ergonomic researches to allow the driver to work long and fatigue-free. For a quick orientation the well-known colour coding of the control elements have been implemented. And for an extremely smooth and precise control action when shifting a gear, using a spool valve or selecting the PTO speeds a new sheath design for the mechanical controls has been developed.

## HIGHLIGHTS

- > Advanced 4-pillar cab design for unobstructed outward visibility
- > Extraordinary configurability
- > Folding passenger seat available as an option
- > Hydro Silent-Block mounts or mechanical cab suspension for minimised on-board vibration



> 6115 C Powershift TopVision cab.





> Adjustable steering wheel.

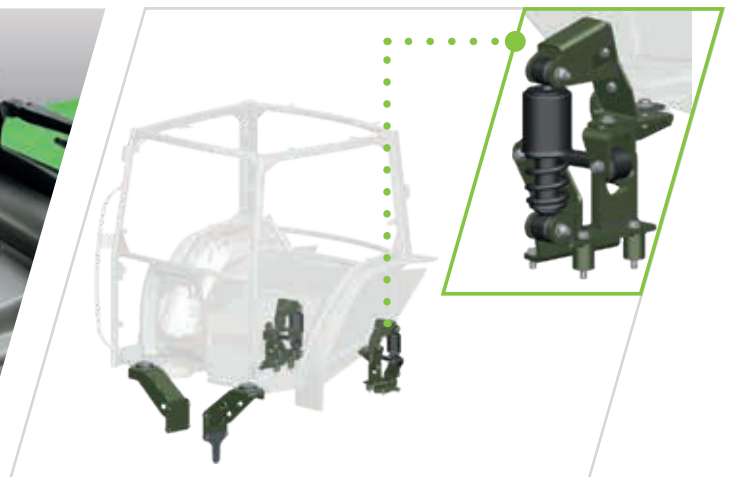

> Mechanical cab suspension.



# HIGHLIGHTS

- > New multifunctional armrest satellite with the main controls
- > New dashboard design with InfoCentre<sup>Pro</sup>
- > Proportional electronic joystick for hydraulic controls
- > Fully programmable jolly buttons



> Adjustable steering wheel with InfoCentre<sup>Pro</sup>.



> The acclaimed MaxCom joystick equipping TTV versions is a concentrated package of high technology which lets the driver control all the main functions of the machine in complete comfort with a single hand.



# // TOPVISION<sup>Pro</sup>

It's all about comfort.

Models with RVshift and TTV transmission are equipped with the TopVisionPro cab which gives, compared to TopVision and TopVision<sup>+</sup>, the possibility to add even more high tech content and comfort features to the Series 6C. For even greater comfort while working at night the front console includes ambient lights. In addition, the cab is equipped with the InfoCentre<sup>Pro</sup> that offers a high resolution screen for displaying all the information necessary concerning the status of the tractor in a clearly legible format.

With TopVision<sup>Pro</sup> the models are also ready for farming 4.0. The iMonitor allows the operator to manage all the functions of the machine. The fully integrated Performance Steering option offers also a quick steer function for reduced steering wheel turns on the headlands or while working with the front loader. Additionally to ISOBUS all models can be also equipped with the most advanced and sophisticated autoguidance and telemetry systems.

Perfect ergonomics are ensured thanks to the satellite armrest installed on the seat. This lets the operator access all main control functions without moving their right arm, eliminating the shoulder strain caused by the continuously motions typically experienced when using controls on side consoles. The armrest allows effortless fingertip control of transmission, engine, PTO and other tractor functions, making even the longest working day less tiring. If equipped with electronic spool valves a proportional joystick is fitted in order to control with absolute precision the spool valves and, if installed, the front lift, the Comfort Package or the front loader. The armrest of models with RVshift transmission is equipped with the RVshift controller, a completely new developed joystick. Thanks to it, the transmission control has never been easier.

The RVshift controller is managing the up and downshifts of the transmission through an easy push forward or pull backward. Additionally through a push to the left, the driving speed can be saved and reactivated. Additionally an "Advanced" version of the RVshift controller features 3 additional jolly buttons and a smart thumbwheel which are freely programmable by the user to suit the needs of the specific task. The armrest of Models with TTV transmission is equipped with the MaxCom joystick (common to high range DEUTZ-FAHR tractors). The MaxCom joystick allows the operation of the rear lift, of two cruise speeds, the change of direction and includes as standard 2 freely programmable jolly buttons and the ComforTip headland management. Linked to electronic spool valves, the MaxCom joystick includes also two thumb wheels for the operation of two rear hydraulic valves or the control of the front lift and Comfort Package or a mix of both.



> USB sockets.



> Left console with flat storage area or portable cooling box.

# // FRONT LOADER

It's all about versatility.

The extreme versatility of the new Series 6C truly comes to the fore when these tractors are used with a front loader. This is why these tractors are available from factory with a kit for the installation of a front loader. The Ready Kit provides the frame to connect the front loader to the tractor, all the hydraulic/electric connections and the control joystick (mechanical or electronic). The joystick is always perfectly integrated in the cab and features besides the P1/P2/P3 button also different comfort functions. The mechanical joystick is additionally equipped with two push buttons allowing an up and downshift of the Powershift steps. Instead the electronic joystick features additionally an integrated thumbwheel which not only allows an up and downshift but

also the change of direction. A highly appreciated function is the renowned Stop&Go system which lets the driver stop the tractor and set off again using the brake pedals alone.

This function has been improved on the RVshift models: in addition to the traditional Stop&Go system, also a Stop&Hold function has been introduced, keeping the tractor on hold until the throttle pedal gets pressed again. Tractors with TTV transmissions are instead equipped with the PowerZero function, which ensures unparalleled safety and precise vehicle control even on the steepest gradients.

These remarkable features are complemented by a host of other functions and characteristics geared specifically to making handling loads easier and more productive:



> Hydro-Fix.

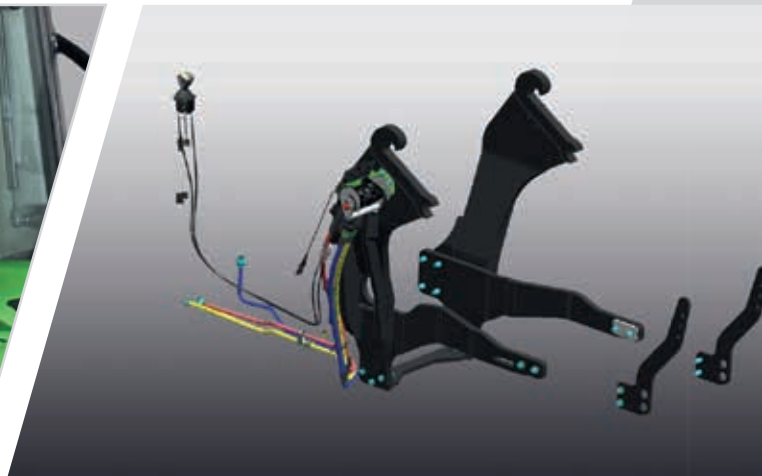

> The Ready Kit also includes a specific hydraulic circuit for working with a loader and a dedicated controller joystick next to the drive seat.



> Electronic joystick for front loader control.





## HIGHLIGHTS

- > Ready Kit factory fitted
- > FOPS-compliance high visibility roof
- > Features designed specifically for front loader application
- > New Stop&Go functionalities (RVshift) or PowerZero (TTV)

this includes the PowerShuttle with 5 user-selectable responsiveness settings, hydraulic systems with a capacity of up to 120 l/min, a dedicated steering pump ensuring impeccable manoeuvrability even at low engine speeds, a FOPS certified high visibility roof and the optional SDD function or EasySteer system which reduce the number of steering turns needed to manoeuvre.

The FZ front loaders which are recommended on the new Series 6C have been developed to be the perfect match for the models of the Series 6C. They feature arms with a flat cross section and hydraulic lines routed rationally along the contours of the loader for maximised manoeuvrability, best visibility and safety.

The coupling with the attachment mounted on the loader can be controlled in complete comfort from the driver seat, while the Comfort Drive function maximises productivity and usability by significantly reducing oscillation when transporting loads. The Z-kinematics and intelligent placement of the centre cross bar ensure an unobstructed forward view of the load from the driver seat, while all joints and bushes can be lubricated simply from the exterior of the lift via easily accessible greasing points.



# // 360° SAFETY

It's all about class-beating safety.

The sense of security offered by a machine boasting top class passive and active safety solutions contributes significantly to operator productivity. In keeping with this principle, DEUTZ-FAHR has equipped the new Series 6C with the best technological solutions available today. Developed entirely in-house, the front axles are designed and built to maximise traction and safety in all conditions with, for example, electrohydraulic engagement of 4WD and differential locks. These two functions can also be automated on machines equipped with ASM. As an option, all models of the new Series 6C are available with a front axle suspension system. Complete with double acting hydraulic cylinders for effective self-levelling, and together with the mechanical cab suspension this feature substantially improves the driver comfort both in the field and on the road. All models of the new Series 6C boast true all-wheel braking, with disc brakes on all four wheels, for superior safety especially when driving on roads in hilly or mountainous areas or at high speed. Models with RVshift and TTV transmission come as standard with PowerBrake pump, a brake booster system ensuring outstanding braking performance with less pedal effort. Also standard on these models is the Hydraulic Parking Brake (HPB), a combined mechanical-hydraulic system which applies a constant pressure to the rear brake discs to hold the tractor in complete safety in all gradients. The positive result is also a 2.5 HP reduction in power consumption, increasing overall productivity and fuel economy.

For even greater safety and comfort, the optional pneumatic trailer braking system on models with RVshift and TTV transmission includes the new aTBM function (advanced Trailer Brake Management), which reduces the trailer brake response time and optimises the trailer braking behaviour.

Besides the available pneumatic or hydraulic trailer brake systems also the hydraulic engine brake (HEB) can be added to the Series 6C. The hydraulic engine brake is a simple, reliable and efficient solution that improves vehicle control during transport and work significantly and reduces the load on the main service brake system and wear. This feature activates the e-Visco fan for an increase in wear-free brake energy absorption and can adjust, on models with RVshift or TTV transmission, even the intensity of deceleration – which is unique on the market. In that way the speed of the tractor can be slowed down or if needed maintained constantly which is an added value while baling in hilly conditions.

For uncompromised safety in poor light conditions, the new Series 6C is available also in a powerful full LED version. This includes not only 12 LED working lights (8 working lights on the roof, 2 on front pillar and 2 on the bonnet) and two LED rotary beacons but also LED driving lights, LED turning indicators as well as LED position and brake lights. Thanks to this, even the darkest night turns into day and allows you to achieve with the 6C best working results.

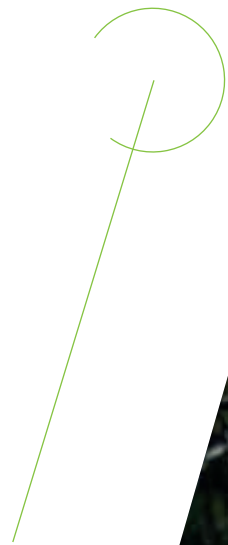

> The braking system features disc brakes on all four wheels.



> Hydraulic Engine Brake activation.



# HIGHLIGHTS

- > Suspended front axle with ASM system and 4-wheel brakes
- > Hydraulic Engine Brake - HEB
- > Hydraulic Parking Brake - HPB
- > Powerful LED lights package



> Electrohydraulic front axle management.

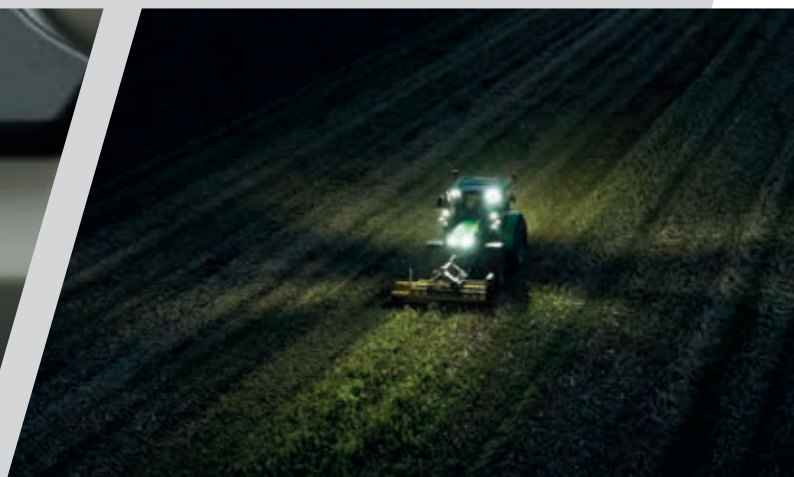

> The extremely potent LED light pack ensures excellent visibility whether driving on public roads or working in the field.

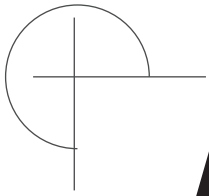

# // WARRIOR EDITION

It's all about exclusivity.

For owners who like to stand out from the crowd, DEUTZ-FAHR offers the coveted Warrior equipment variant for the new Series 6C models. Take advantage of the special Warrior LED lighting pack and enjoy the luxury of the comfortable pneumatic seat, the air conditioning system and the audio system with DAB+. With taking the choice of a Warrior Edition the new Series 6C makes a bold impression and stands out unmistakably from the crowd.



> The Warrior models feature a wide range of high-quality components as standard, underlining the exclusive character of this equipment variant.





## HIGHLIGHTS

- > Pneumatic suspended seat
- > DEUTZ-FAHR floor mat
- > Warrior decal on bonnet
- > Air conditioning
- > LED lights package available
- > Warrior colour: black
- > Special black Warrior covers for wheel hubs



The logo for SDF Smart features two green slanted bars on the left, followed by a grey circular icon with three interlocking shapes. To the right, the text 'SDF' is in orange and 'Smart' is in grey.

# // SDF Smart

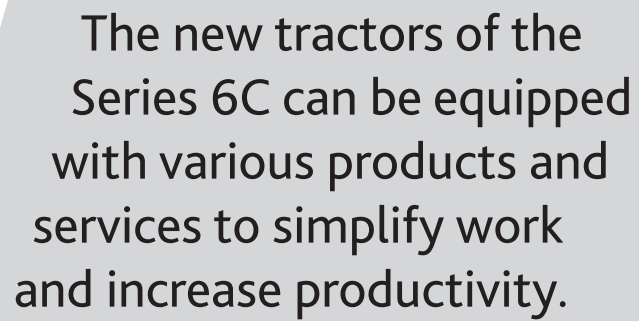
A grey trapezoidal text box with a thin green line extending from its top-left corner.

The new tractors of the Series 6C can be equipped with various products and services to simplify work and increase productivity.





# Farming Solutions



# // SDF SMART FARMING SOLUTIONS

It's all about connectivity.

The tractors of the new 6C family offer class-beating technology, letting you get on with your work with even more intelligent solutions. Automated guidance systems maximize operator comfort. The tractors of the new 6C family may be equipped as an option with the most advanced and sophisticated autoguidance and telemetry systems. Centimetre precision avoids wasteful overlapping, saving fuel, reducing component wear and minimizing use of the tools necessary for production. The connectivity solutions offered by DEUTZ-FAHR make interaction between the office and machinery even simpler.

The new SDF Fleet Management suite puts the user in total control of the new Series 6C. The application lets the owner keep track of the position of the tractor in real time, wherever it is. SDF Fleet Management can also be used as an effective tool for planning maintenance, by making use of its notification functions, and for acquiring data relative to performance and fuel consumption. With the SDF Fleet Management application, dealers can always assist drivers in case of any upcoming issues that may occur. This reduces downtime and increases operation reliability of customer's machine.

## HIGHLIGHTS

- > iMonitor as centralised interface for managing a number of different applications for guidance, data management, ISOBUS and additional optional features like XTEND or AUTO-TURN
- > SDF Guidance with plenty of comfortable features and the new SR20 GNSS receiver for superior precision
- > Wide number of ISOBUS functions like automatic Section Control with up to 200 sections
- > SDF Data Management for reliable data exchange e.g. with Agrirouter
- > SDF Fleet Management for total remote control of machine data

- 
- > XTEND function with tablet, control of implements via ISOBUS UT while being outside of the cab.



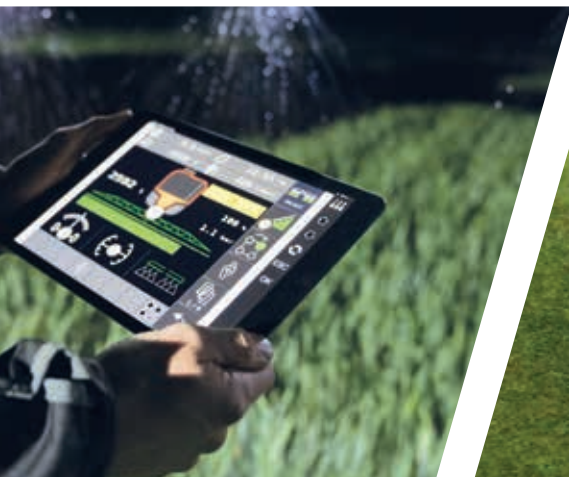

> SDF Guidance: plenty of features (like AUTO-TURN) for highest convenience.



# // iMonitor

It's all about usability.

The iMonitor is the central control element and comes along with updated graphics for a new user experience that is now even more simple and intuitive to use. An 8" monitor size is available, allowing the driver to manage all the most important functions of the machine, such as tractor settings, guidance, ISOBUS implement control and data management. You can split the screen into different fields to display dedicated functions, while an effective anti-glare coating ensures that all the information is clearly visible. State of the art touch screen operation makes it even more comfortable. Intuitive and immediate usability are crucial given the large number of functions controllable from the terminal. Support functions such as quick guides and icon tooltips, combined with a clear menu structure ensure simple, intuitive use. And if the operator still has any doubts on the functions of the interface, these can be resolved quickly by using the Remote Support function. iMonitor is a highly practical interface connecting the driver, tractor, implement and office. Besides a huge number of features available already as standard, it is even possible to unlock further functions and by this increase also the level of usability – such as the XTEND function which allows screens to be extended onto external tablets.

## SDF Guidance

Modern autoguidance systems not only improve productivity by reducing driver stress, they also offer significant time savings by ensuring greater precision during work in the field. The SDF Guidance application allows the driver to work comfortable and relaxed, and always with the highest precision.

### SR20

SR20 is a new GNSS auto-steering receiver designed for highest accuracy and performance in field. It is capable for the reception of all important satellite systems (GPS, GLONASS, GALILEO, QZSS and Beidou) to achieve reliable satellite tracking for consistent accuracy during all conditions. As the hardware contains as standard a 3-axis gyroscope for detecting smallest movements, its accuracy level can easily be upgraded e.g. from DGPS corrections like EGNOS to RTK.

### AUTO-TURN

In combination with Performance Steering the Series 6C offers optionally the AUTO-TURN feature. After activation the tractor automatically turns on the headlands which relieves the driver, reduces the time on the headland and gives the possibility to monitor and optimise the implement.

### ISOBUS

Electronics increase the safety, precision and efficiency of agricultural machinery. With ISOBUS, the operator can now control all compatible implements from a single monitor (UT). The iMonitor can be used as a central controller for all ISOBUS applications and for managing a wide variety of operations. Many functions are available without activating a license: such as assigning AUX (AUX-N) functions, automatic switching of up to 200 sections (TC-SC). Processing application maps (TC-GEO) can be utilised in Advance mode.



> AUTO-TURN feature.





> SDF Guidance assists drivers: All day long, in every condition, with reliable high accuracy.

## State of the art technology for total connectivity.

Optimise operations. Increase efficiency. Linking machines, to the office and to any other external sources simplifies various work processes. SDF Smart Farming Solutions offer practical solutions for managing key data and staying connected at all times. The user is completely free to make his own choices and decisions at any time, while all data remain the sole property of the user.

### SDF Fleet Management

With the new SDF Fleet Management application, SDF offers customisable solutions for the real-time management of key data concerning the operation of the machine. Our clients benefit significantly from being in total control of their machines and from the ability to manage a host of vital data, such as tracking data relative to activities. The SDF Fleet Management suite of applications is the centralised control interface for analysing telemetry data from DEUTZ-FAHR machines. Tractor data is transmitted in real time over a mobile internet connection to the application, which allows users to analyse, monitor and even optimise the use of their machinery. The "map" view shows the location and status of machines or an entire fleet, and can also display historical data. On request, you can set up virtual fences to receive warnings if a machine leaves the area. Error messages may be forwarded to the technical support team of the dealership, and used to predict failure and reduce unnecessary machine down time. Thanks to the Remote Support application, dealers can easily access to the iMonitor after drivers permission to assist for eventual upcoming operational questions or issues.

### SDF Data Management

Efficient Data Management is becoming increasingly important to optimize work processes for farm and field management. SDF uses standard file formats like shape or ISO-XML for more reliable data exchange. This allows users to keep track of what is going on at all times with coherent data transferred in a coordinated manner.



Agrirouter is a universal platform permitting reliable and neutral data exchange between a wide variety of different terminals. The platform simplifies data exchange and, therefore, work processes, reducing office workload and improving economic efficiency, freeing up valuable time for other activities. As a neutral data exchange platform, this is a solution to one of the biggest hurdles for digitalisation in agriculture, allowing farmers and contractors to exchange data between machine applications and agricultural software applications from different manufacturers. Each user can create a free personal Agrirouter account and configure it individually. The paths to and from which data are transferred are defined by the user only in the settings menu. A list of partners and additional information can be found at [www.my-agrirouter.com](http://www.my-agrirouter.com). The new Series 6C can optionally be fitted with all the necessary hardware from factory, existing DEUTZ-FAHR tractors may be retrofitted subsequently with the required components.



> Connect the Series 6C with your dealer for fast and comfortable support.



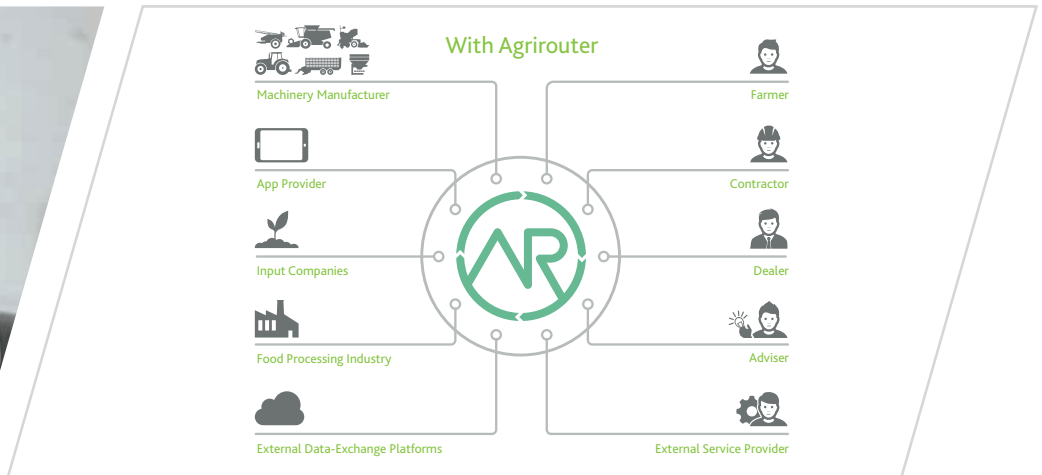

> The Agrirouter allows users to communicate from different areas of application, ensuring reliable data exchange.



# // OPTIONS

It's all about tailor-made.

No matter if the new Series 6C is used for mixed application, forage harvest, cash crop farming, heavy pulling application, in breeding farms or in municipalities, the huge choice of optional accessories offered by DEUTZ-FAHR lets each owner tailor the tractor to their specific needs. With different tyre / rim options from factory almost all work profiles are covered. The offering of standard agricultural tyres from 460/85 R38 to 600/65 R38 allowing to find the best tyre set fitting the work profile. For customers focusing on plant protection and fertilisation in late growth stages the new Series 6C can be ordered ex-factory also with narrow track tyres (rear dimension of 270/95 R48) offering a high ground clearance of up to 505 mm. And for municipalities and customers working mainly on the road, also special municipal tyres (rear dimension of 480/80 R38) are available ex works (max tyre sizes vary on 6115 C with Powershift transmission). Similar flexibility is also given with the offered trailer hitches. The offering of different hitches fulfil the markets needs and allow each customer to connect his trailers and implements to the Series 6C. And of course every type of trailer braking system currently in use is available, with a choice of hydraulic, pneumatic or combined systems, making the Series 6C the ideal solution even for heavy duty road transport use.

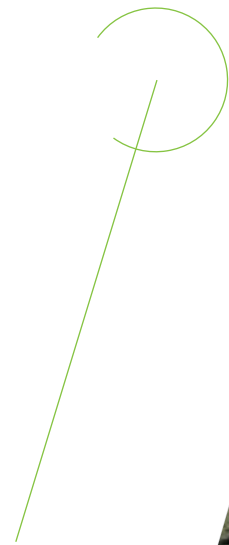

> Foldable passenger seat.



> DAB+ radio availability.





> Manual A/C and bracket for external monitor/device.



# // MAINTENANCE AND SERVICE

It's all about simply maintenance.

Intelligent solutions for less and shorter maintenance times, such as:

- Prolonged oil change intervals (FARMotion engines)
  - 600 h or once a year engine oil
  - 1200 h or once a year transmission oil
- Sight glasses for visually inspecting levels of:
  - coolant
  - transmission/hydraulic oil
- Engine oil dipstick accessible without opening the cowl
- Handy battery port on the right side for jump start

DEUTZ-FAHR tractors are traditionally easy to maintain machines. Extended service intervals, reduced machine downtimes and easy access to all maintenance points increase the overall economic efficiency of every single model. The tractors of the new 6C family not only follow this tradition but improve it even further.

## DEUTZ-FAHR SERVICE

NOT JUST CLOSE, BUT ALSO FAST.

- > High quality requirements
- > Original spare parts in premium quality
- > Fast and efficient spare parts service
- > On-time deliveries – worldwide
- > Varied product range
- > Excellent price-performance ratio
- > Remote Support for fastest service







TECHNICAL DATA	POWERSHIFT			RVSHIFT			TTV			
	6115 C	6125 C	6135 C	6115 C	6125 C	6135 C	6115 C	6125 C	6135 C	
<b>ENGINE</b>										
<b>FARMOTION</b>										
Model		FARMotion			FARMotion			FARMotion		
Emission level		Stage IV EPA			Stage IV EPA			Stage IV EPA		
Cylinders/Displacement	n°/cc	4/3849			4/3849			4/3849		
Turbocharger with charge air cooling		●			●			●		
Visco cooling fan		●			●			●		
e-Visco cooling fan		-	○		○			○		
Injection @ pressure	Type/bar	Common Rail @ 2,000								
Max. power (ECE R120)	kW/HP	85/116	93/126	100/136	85/116	93/126	100/136	85/116	93/126	100/136
Power at rated speed (ECE R120)	kW/HP	80.6/110	88.2/120	94.9/129	80.6/110	88.2/120	94.9/129	80.6/110	88.2/120	94.9/129
Speed at maximum power	rpm	2000			2000			2000		
Max. engine speed (rated)	rpm	2200			2200			2200		
Max. torque	Nm	462	506	544	462	506	544	462	506	544
Speed at maximum torque	rpm	1600			1600			1600		
Air filter with dust ejector		●			●			●		
Fuel tank capacity	l	160	180		180			180		
AdBlue capacity	l	12	13		13			13		
Oil change interval	Hours	600			600			600		
<b>TRANSMISSION</b>										
Model		PS transmission T5350	PS transmission T5441		RVS transmission T5441			TTV transmission T5441		
Transmission ratio		1.3133	1.3461		1.3417			1.3417		
PowerShuttle with 5 different settings		●			●			●		
<b>POWERSHIFT</b>										
Gearbox	n°	5 gears x 3 Powershift steps			-			-		
N° of speed with 3 Powershift steps	n°	30 + 30			-			-		
N° of speed with 3 Powershift steps and creeper	n°	60 + 60			-			-		
Stop&Go		●			-			-		
Automatic Powershift (APS)		●			-			-		
Top speed 40 km/h ECO	rpm	1780			-			-		
<b>RVSHIFT</b>										
Gearbox		-			RVshift			-		
N° of Powershift steps (FW + RW)	n°	-			20 + 16			-		
Creeper		-			○			-		
Cruise Control		-			●			-		
Stop&Go with advanced functionality		-			●			-		
Automatic Powershift (APS)		-			●			-		
Top speed 40 km/h SuperECO	rpm	-			1605			-		
Top speed 50 km/h ECO	rpm	-			1910			-		
<b>TTV</b>										
Gearbox		-			-			TTV – Stepless transmission		
Cruise Control		-			-			2 each direction		
Driving strategies		-			-			Auto/Advanced Auto/PTO/Manual		
Active standstill (PowerZero)		-			-			●		
Top speed 40 km/h SuperECO	rpm	-			-			1605		
Top speed 50 km/h ECO	rpm	-			-			1910		



TECHNICAL DATA	POWERSHIFT			RVSHIFT			TTV			
	6115 C	6125 C	6135 C	6115 C	6125 C	6135 C	6115 C	6125 C	6135 C	
<b>HYDRAULICS AND LINKAGE</b>										
Pump flow (STD)	l/min	90			90			90		
Pump flow (OPT)	l/min	-	120 LS		120 LS			120 LS		
Separate steering pump		●			●			●		
Spool valves controls	Type	Mechanical			Mechanical + Electronic			Mechanical + Electronic		
Hydraulic auxiliary control valves (STD)	n°	3	3		3			3		
Hydraulic auxiliary control valves (OPT)	n°	4	up to 4 + 1 diverter rear/1 diverter front		up to 5 rear/1 diverter front/1 for front lift			up to 5 rear/1 diverter front/1 for front lift		
Aux valves settable in time and flow - proportional engagement		-			○			○		
Power Beyond (standard couplers)		-	○		○			○		
Automatic lower link stabilizers (mechanical)		○			○			○		
Rear linkage lifting capacity (STD)	Kg	5410	5000		5000			5000		
Rear linkage lifting capacity (OPT)	Kg	-	7000		7000			7000		
Rear linkage lift category	Cat.	II	II/IIIN		II/IIIN			II/IIIN		
External operation on rear fenders		●			●			●		
Front linkage		○			○			○		
Front linkage lifting capacity	Kg	3000			3000			3000		
Hydraulic upper link rear		○			○			○		
Oil change interval	Hours	1200			1200			1200		
<b>PTO</b>										
Rear PTO 540/540ECO/1000/1000ECO		●			-			-		
Rear PTO 540/540ECO/1000		-			●			●		
Rear Auto PTO		●			●			●		
Front PTO 1000		○			○			○		
<b>AXLES AND BRAKES</b>										
Model		SDF			SDF			SDF		
Suspended front axle		○			○			○		
Electro-hydraulic differential lock 100%		●			●			●		
ASM system		-	○		○			○		
Steering Double Displacement SDD		○			○			○		
Performance Steering ready with EasySteer function		-			○			○		
Steering angle	degrees	55			55			55		
Brake booster (PowerBrake)		-			●			●		
Mechanical parking brake		●			-			-		
Hydraulic Parking Brake (HPB)		-			●			●		
Pneumatic trailer brake		○			○			○		
Hydraulic trailer brake with Dual Mode function		○			○			○		
Hydraulic Engine Brake (HEB)		-	○		○			○		
<b>ELECTRICAL SYSTEM</b>										
Voltage	V	12			12			12		
Standard battery	V/Ah	12/100			12/100			12/100		
Alternator	V/A	14/170			14/170			14/170		
Starter motor	V/kW	12/3			12/3			12/3		
External socket		●			●			●		
Interface for attachments 11786 (7-pole)		○			○			○		

TECHNICAL DATA	POWERSHIFT			RVSHIFT			TTV		
	6115 C	6125 C	6135 C	6115 C	6125 C	6135 C	6115 C	6125 C	6135 C
<b>TOPVISION CAB</b>									
4-pillar cab		TopVision	TopVision <sup>+</sup>		TopVision <sup>pro</sup>			TopVision <sup>pro</sup>	
Mechanical cab suspension		-	○		○			○	
Adjustable and telescopic rear view mirrors			●		●			●	
Heated and electronic adjustable rear view mirrors		-	○		○			○	
Air conditioning			○		○			○	
High visibility roof			○		○			○	
High visibility roof FOPS			○		○			○	
Multifunction satellite armrest			-		●			-	
Multifunction satellite armrest with Advanced function			-		○			-	
Multifunction satellite armrest with MaxCom joystick			-		-			●	
iMonitor with 8"			-		○			○	
AUTO-TURN			-		○			○	
XTEND			-		○			○	
ISOBUS (with rear and in-cab connectors)		-	○		○			○	
VRC (Variable Rate Control)		-	○		○			○	
SC (Section Control) 200 sections		-	○		○			○	
SR20 RTK receiver		-	○		○			○	
CTM connectivity module			○		○			○	
Attachment bracket			○		○			○	
ComforTip Professional			-		-			○	
Seat Max with mechanical suspension			●		●			●	
Seat Max-Professional Plus with pneumatic suspension and swivel			○		○			○	
Passenger seat			○		○			○	
Pre-arrangement for radio with antenna and loud speakers			●		●			●	
High-level DAB+ radio with Bluetooth			○		○			○	
8x Halogen work lights on cab roof			●		●			●	
Up to 12x LED work lights			○		○			○	
Up to 2x Beacon light LED			○		○			○	
LED driving light			○		○			○	
<b>FRONT LOADER</b>									
Pre-arrangement Ready Kit with mechanical joystick (including Hydro-Fix)			○		○			○	
Pre-arrangement Ready Kit with electronic joystick (including Hydro-Fix)			-		○			○	
Possible Front loader models		FZ 41-29	FZ 41-33   FZ 43-27		FZ 41-33   FZ 43-27			FZ 41-33   FZ 43-27	
Overloading height	mm	3890	3890   4110		3890   4110			3890   4110	
Breakout force 800 mm before the pivot point	daN	3540	3850   3540		3850   3540			3850   3540	



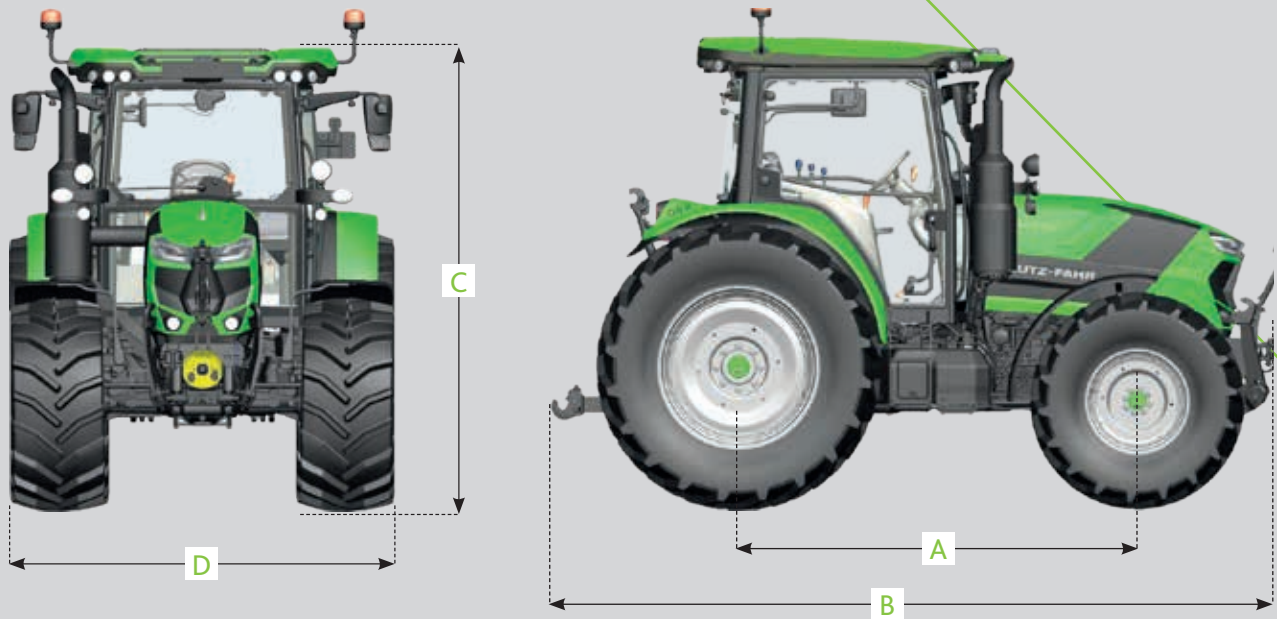

TECHNICAL DATA		POWERSHIFT			RVSHIFT			TTV		
		6115 C	6125 C	6135 C	6115 C	6125 C	6135 C	6115 C	6125 C	6135 C
<b>DIMENSIONS AND WEIGHTS</b>										
Front tyres (min.)		420/70 R24"	380/70 R24"		380/70 R24"			380/70 R24"		
Rear tyres (min.)		480/70 R34"	480/70 R34"		480/70 R34"			480/70 R34"		
Front tyres (max.)		440/65 R28"	540/65 R24"		540/65 R24"			540/65 R24"		
Rear tyres (max.)		540/65 R38"	600/65 R38"		600/65 R38"			600/65 R38"		
Wheelbase (A)	mm	2480	2480		2510			2510		
Length (B)	mm	4425	4500		4530			4530		
Height (max.) (C)	mm	2785	2860		2860			2860		
Width (max.) (D)	mm	2374	2431		2431			2431		
Ground clearance	mm	480	480		480			480		
Front axle width (flange to flange)	mm	1770	1770		1770			1770		
Rear axle width (flange to flange)	mm	1740	1740		1740			1740		
Unladen weight, front	Kg	2000	2100		2200			2200		
Unladen weight, rear	Kg	2600	2900		3300			3300		
Total unladen weight	Kg	4600	5000		5500			5500		
Wheel weights			○		○			○		
Maximum permissible axle load, front	Kg	3000	3200		3200			3200		
Maximum permissible axle load, rear	Kg	5000	5000		5500			5500		
Maximum permissible weight	Kg	7500	8000		8500			8500		

● = standard ○ = option – = not available

Technical data and figures are only provided for guidance. DEUTZ-FAHR is committed to continuously adapting its products to your requirements and therefore reserves the right to make updates without prior notice.



Follow us on   

DEUTZ-FAHR is a brand of  SDF

*To discover more please contact your dealer or visit [deutz-fahr.com](http://deutz-fahr.com)*

*Marketing-Communication Service – Code 308.8918.3.4-0 – 09/23*

